

Hawa Concepta 木制旋转推拉门 家具设计的新趋势

搭配Hawa Concepta 25/30/40/50装置,可以让门板以90°开启后滑行插入橱柜口袋或内墙。这为步入式衣柜、落地式结构和其他储物方案开辟了全新的视角。该解决方案的美观性和功能性给客户留下极深的印象,因为柜门位于柜体一侧,只占用橱柜内部极小的壁龛宽度,而且能够用于大多尺寸的衣橱柜门。

Hawa Concepta通过导轨,拉手等多种选项,满足各式各样创意的设计需求。在安装过程中,他也不会让您走弯路:除了预钻定位孔和隐藏式铰链安装孔外,无需其他处理,因为配件是通过螺钉固定在中间板上,后期可以随时从前面对配件进行调节。



应用场景

多功能空间转换的家具结构, 如: 工作区、洗衣机/烘干机组合、步入式橱柜, 以及隐藏式厨房

产品亮点

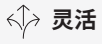

灵活

轻松适应各种柜门尺寸

可与Hawa Folding Concepta相结合, 无需中竖板, 轻松实现两门、三门或四门设计, 为柜门设计增添无限可能



高效

高效安装, 所有零件可通过预钻孔, 用螺丝固定



舒适

柜门73 mm 外沿不会形成阻挡
导轨0 mm间隙和阻尼回收系统
静音导向毛刷适用于多种门宽



美观

优雅的齐平式、落地式或步入式结构

技术标准

门板重量: 25/30/40/50 kg

门板高度: 1250-2850 mm

门板宽度: 300-900 mm

门板厚度: 19-50 mm

选装配件

- 口袋连接器
- 门板拉直器

安装实例

Hawa Concepta 25/30

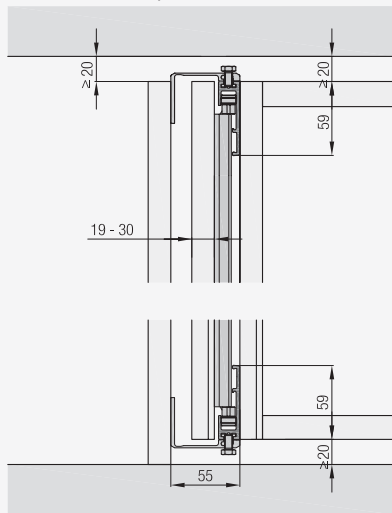

Hawa Concepta 25/30

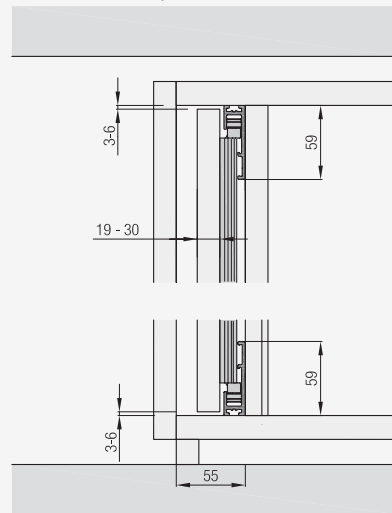

Hawa Concepta 25/30

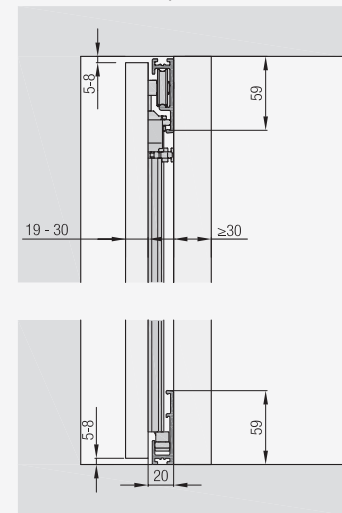

外盖式柜门

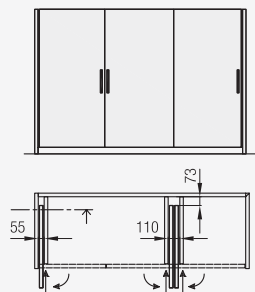

齐平式柜门

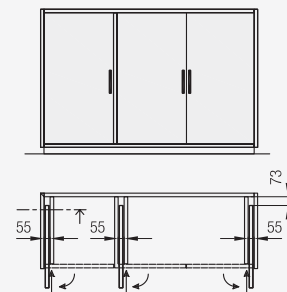

落地柜门, 步入式

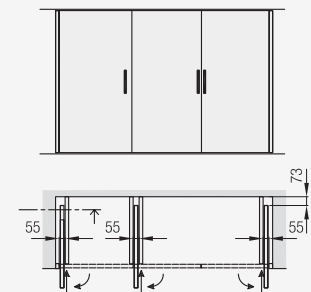

产品系列



Hawa Concepta 25/30
Hawa Concepta 40/50

Hawa Concepta 25/30
Hawa Concepta 40/50



Hawa Concepta 25/30
Hawa Concepta 40/50

适用于25kg旋转推入式木门, 齐平式设计能够满足多功能空间自由转换

产品亮点

-  **灵活** 门板尺寸灵活, 设计自由度高
-  **舒适** 采用阻尼回收系统和集成式阻尼铰链, 操作柔顺、静音

技术标准

-  门板重量 10-25 kg
-  门板高度 1250-1850 mm
-  门板宽度 300-750 mm
-  门板厚度 19-50 mm

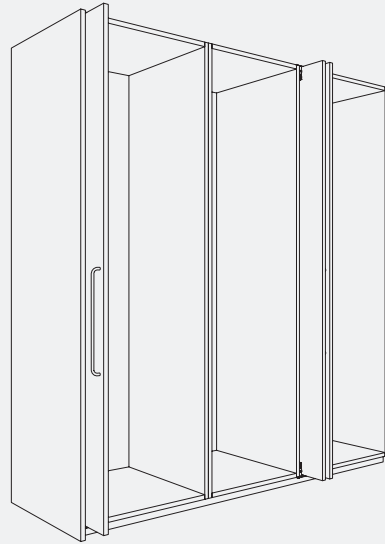

安装实例 外盖式柜门

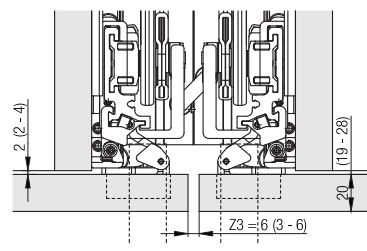
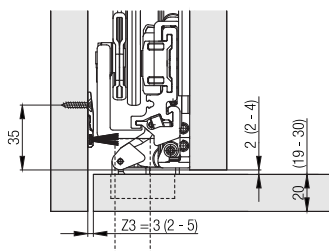
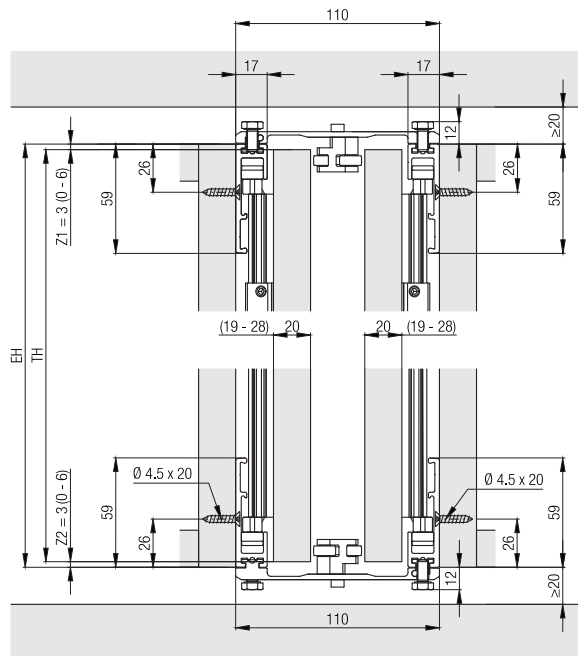
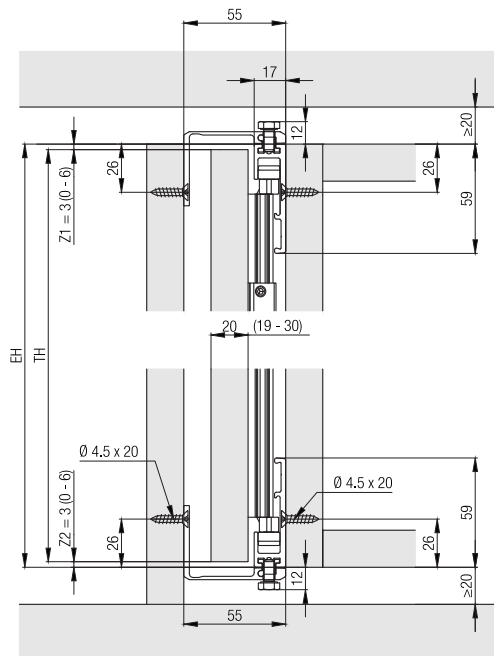

25kg旋转推入式移门套装配件

Hawa Concepta 25, 单门		编号	
		27648	
全套配件包括:		27648	编号
	立柱, 1800 mm, 氧化铝	1	22055
	立柱导向装置, 防震, 带塑料滚轮	2	25656
	扭力盘	1	27704
	剪刀支架, 900 mm, 镀锌钢	1	22592
	剪刀支架前导轨, 氧化铝	1	25592
	剪刀支架后导轨, 氧化铝	1	25596
	剪刀支架限位器, 55 mm, 镀锌钢	1	25855
	隐藏式铰链, 带阻尼器, 镀锌钢, 3件/套	1	27654
	隐藏式铰链专用螺丝, 4x16 mm, 10件/套	1	25935
	限位胶条, 860 mm, 预钻孔, 塑料, 黑色	1	22861

续表见下一栏

接上一栏

	限位胶条专用十字头螺丝, 4x16 mm, 7件/套	1	25562
	导向静音毛刷, 塑料, 黑色, 3件/套	1	25815
	锁止器, Hawa Concepta, 深度可调, 左上角/右下角	1	27657
	锁止器, Hawa Concepta, 深度可调, 右上角/左下角	1	27658
	盖板, 不锈钢, 1对	1	24739
	底部导轨, 728 mm, 氧化铝, 预钻孔	2	24533
	前导轨阻尼器, 带固定架	1	24661
	柜门伸缩器25/50, 带阻尼器, 塑料, 黑色	1	25814
	后导轨阻尼器, 带罩盖, 塑料, 黑色	1	25862
	螺丝, 4.5x20 mm, 22件/套	1	22451
	内六角扳手, 带手柄, 3 mm	1	13164
	辅助安装工具, 塑料, 红色	1	25816

口袋连接器

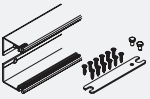
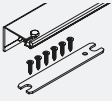
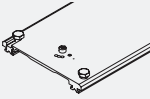
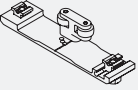
		mm	编号
	55 mm口袋连接器, 单门, 氧化铝, 2件	650	25438
	55 mm口袋连接器, 单门, 氧化铝, 1件	650	23221
		900	23222
	110 mm口袋连接器, 两门, 氧化铝, 1件	650	23223
		900	23224
	110 mm口袋连接器, 两门, 氧化铝, 1件 (安装在固定的底座前面)	26	23225

导向轮

		编号
	嵌入式旋转滑动柜门 (两门) 专用导向轮, 铝	25680

门板拉手

		mm	编号
	门板拉手, 氧化铝	400	22692

门板拉手高度

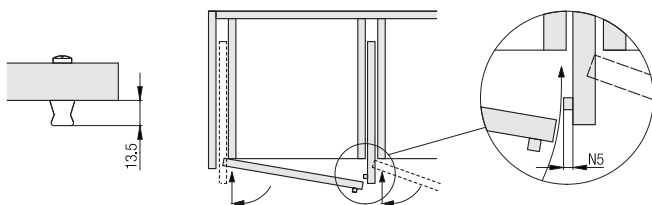

其他安装实例
齐平式柜门

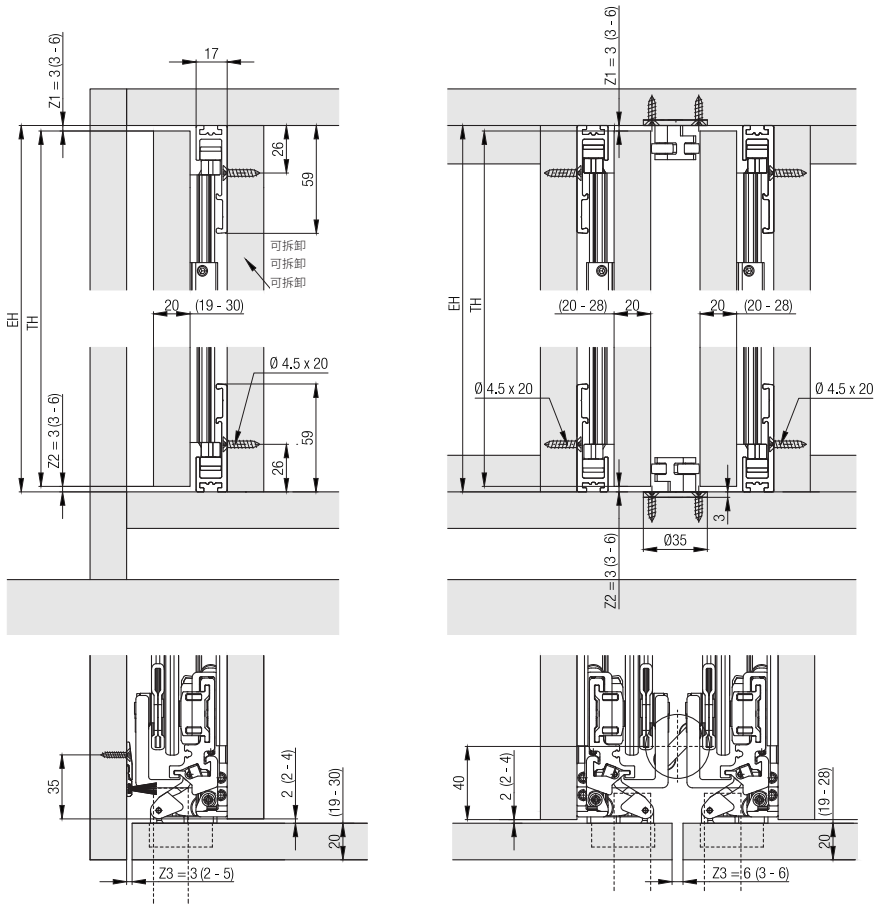

入墙式柜门

柜门厚度: 31-50 mm

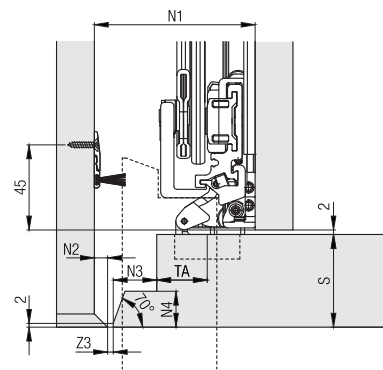
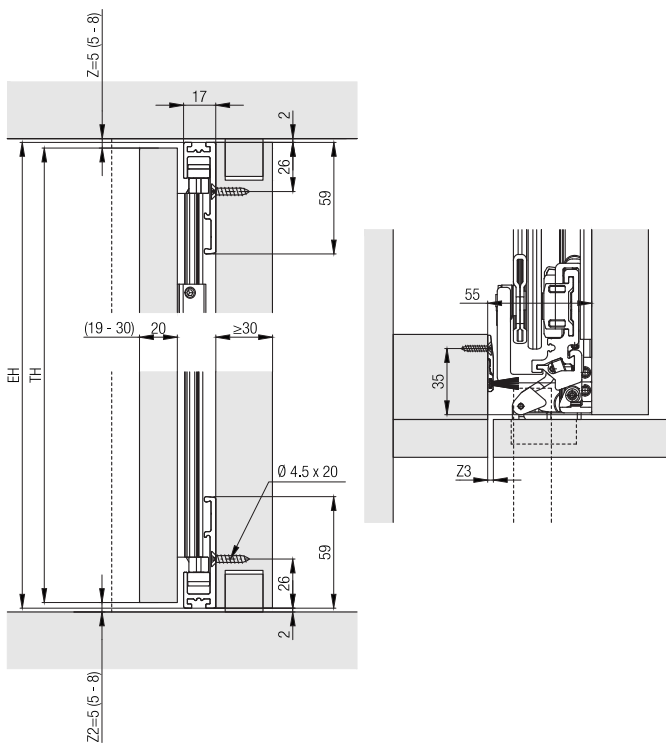

单位:mm

S	N1	N2	N3	N4
19-30	55	0	0	0
33	58	0	3	3
36	63	2	6	5
39	67	3	9	8
42	70	3	12	11
45	75	5	15	14
48	79	6	18	17
50	83	7	21	19

安装深度计算

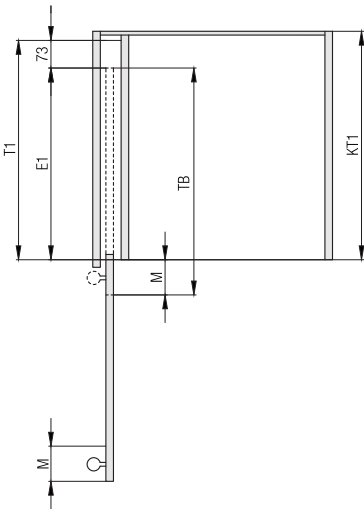

单位: mm

$$T1 = TB - M + 73$$

$$E1 = T1 - 73$$

单位: mm

	T1	TH	E1
Hawa Concepta 25	≤ 650	1250 - 1850	300 - 577

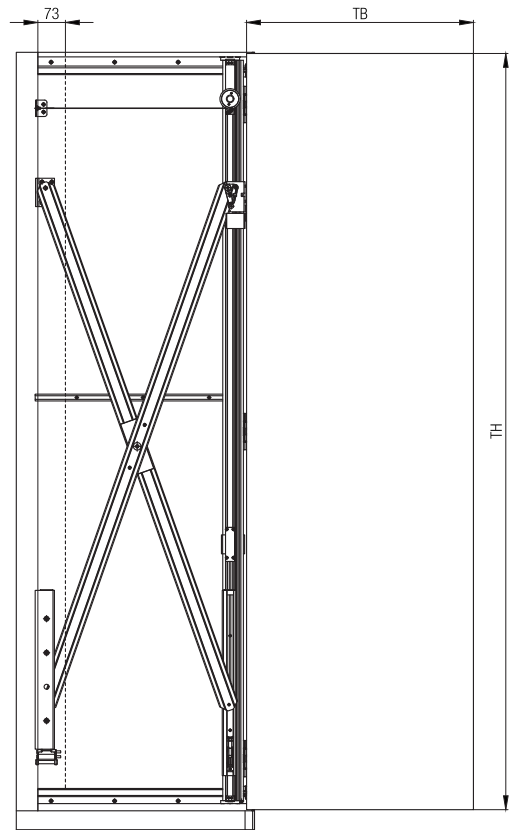

柜门重量及尺寸对照表

最大重量必须根据柜门的尺寸比进行调整。

TH TB	300	350	400	450	500	550	600	650	700	750
1850	25	25	25	25	25	25	25	24	23	22
1800	25	25	25	25	25	25	25	23	22	21
1750	25	25	25	25	25	25	24	22	21	21
1700	25	25	25	25	25	25	24	21	21	20
1650	25	25	25	25	25	25	23	21	20	19
1600	25	25	25	25	25	24	22	20	19	18
1550	25	25	25	25	25	24	21	19	18	18
1500	25	25	25	25	25	23	21	18	18	17
1450	25	25	25	25	24	22	20	18	17	16
1400	25	25	25	25	24	21	19	17	16	15
1350	25	25	25	24	23	21	18	19	16	15
1300	25	25	25	24	22	20	18	15	15	14
1250	25	25	24	23	21	19	17	15	14	13

门板重量 (kg) | TB=门板宽度 (mm) | TH=门板高度 (mm)

选装配件

- 门板拉直器, 从第50页开始



计划/实施

进入 www.concepta.hawa.com, 输入柜体基本尺寸即可得设计方案深化图纸。

有关该产品的更多信息, 请访问 www.hawa.com。

适用于30kg旋转推入式木门, 齐平式设计能够满足多功能空间自由转换

产品亮点

-  **灵活** 门板尺寸灵活, 设计自由度高
-  **舒适** 采用阻尼回收系统和集成式阻尼铰链, 操作柔顺、静音

技术标准

-  门板重量 15-30 kg
-  门板高度 1851-2300 mm
-  门板宽度 300-900 mm
-  门板厚度 19-50 mm

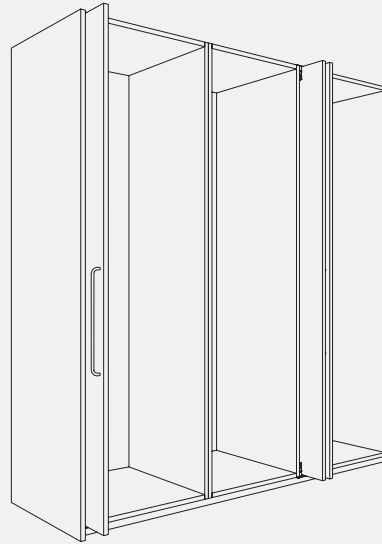

安装实例 外盖式柜门

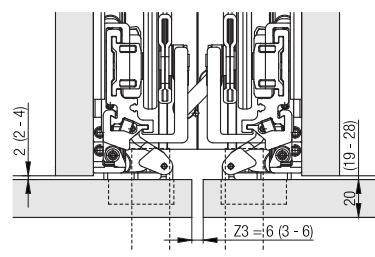
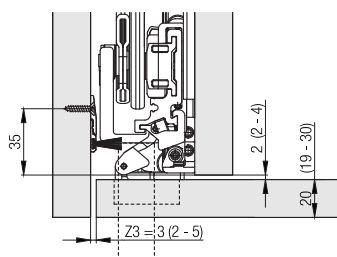
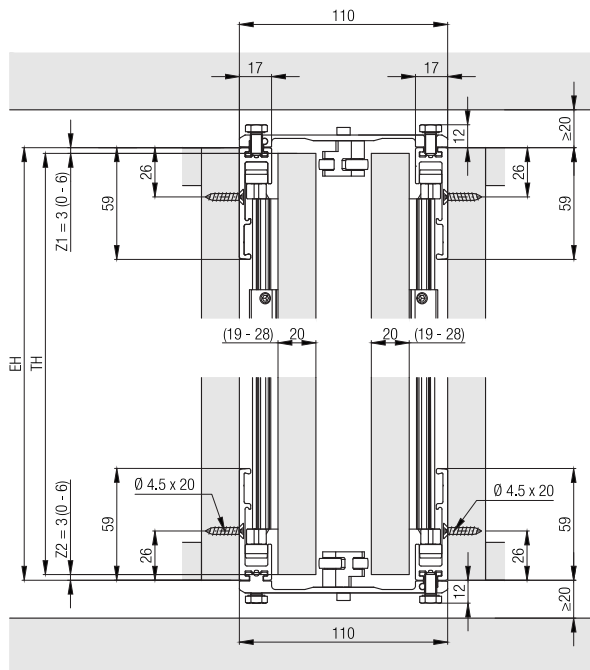
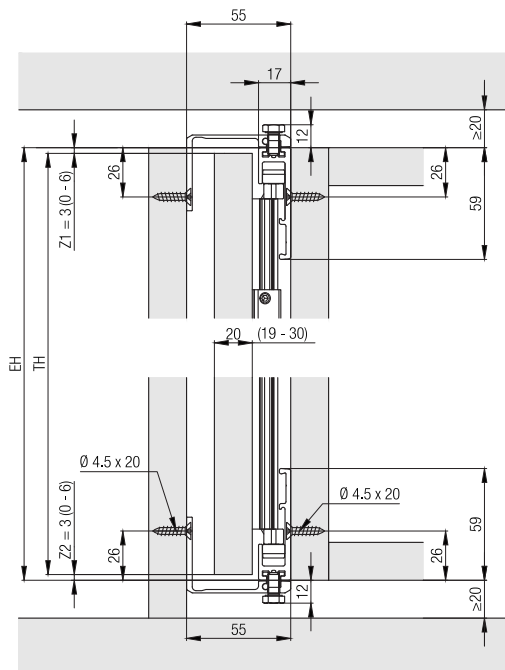

30kg旋转推入式移门套装配件



		编号	
Hawa Concepta 30, 单门		27649	
		27649	编号
全套配件包括:			
	立柱, 2300 mm, 氧化铝	1	24699
	立柱导向装置, 防震, 带塑料滚轮	2	25656
	扭力盘	1	27704
	剪刀支架, 镀锌钢	1	22593
	剪刀支架前导轨, 氧化铝	1	25592
	剪刀支架后导轨, 氧化铝	1	25596
	剪刀支架限位器, 55 mm, 镀锌钢	1	25855
	隐藏式铰链, 带阻尼器, 镀锌钢, 3件/套	1	27654
	隐藏式铰链专用螺丝, 4x16 mm, 10件/套	1	25935
	限位胶条, 860 mm, 预钻孔, 塑料, 黑色	1	22861

续表见下一栏

接上一栏

	限位胶条专用十字头螺丝, 4x16 mm, 7件/套	1	25562
	导向静音毛刷, 塑料, 黑色, 3件/套	1	25815
	锁止器, Hawa Concepta, 深度可调, 左上角/右下角	1	27657
	锁止器, Hawa Concepta, 深度可调, 右上角/左下角	1	27658
	盖板, 不锈钢, 1对	1	24739
	底部导轨, 896 mm, 氧化铝, 预钻孔	2	24535
	前导轨阻尼器, 带固定架	1	24660
	柜门伸缩器30/40, 带阻尼器, 塑料, 黑色	1	25813
	后导轨阻尼器, 带罩盖, 塑料, 黑色	1	25862
	螺丝, 4.5x20 mm, 22件/套	1	22451
	内六角扳手, 带手柄, 3 mm	1	13164
	辅助安装工具, 塑料, 红色	1	25816

口袋连接器

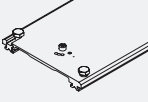
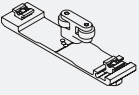
		mm	编号
	55 mm口袋连接器, 单门, 氧化铝, 2件	650	25438
	55 mm口袋连接器, 单门, 氧化铝, 1件	650	23221
		900	23222
	110 mm口袋连接器, 两门, 氧化铝, 1件	650	23223
		900	23224
	110 mm口袋连接器, 两门, 氧化铝, 1件 (安装在固定的底座前面)	26	23225

导向轮

		编号
	嵌入式旋转滑动柜门(两门)专用导向轮, 铝	25680

门板拉手

		mm	编号
	门板拉手, 氧化铝	400	22692

门板拉手高度

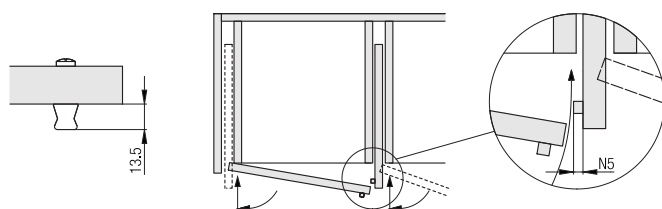

其他安装实例
齐平式柜门

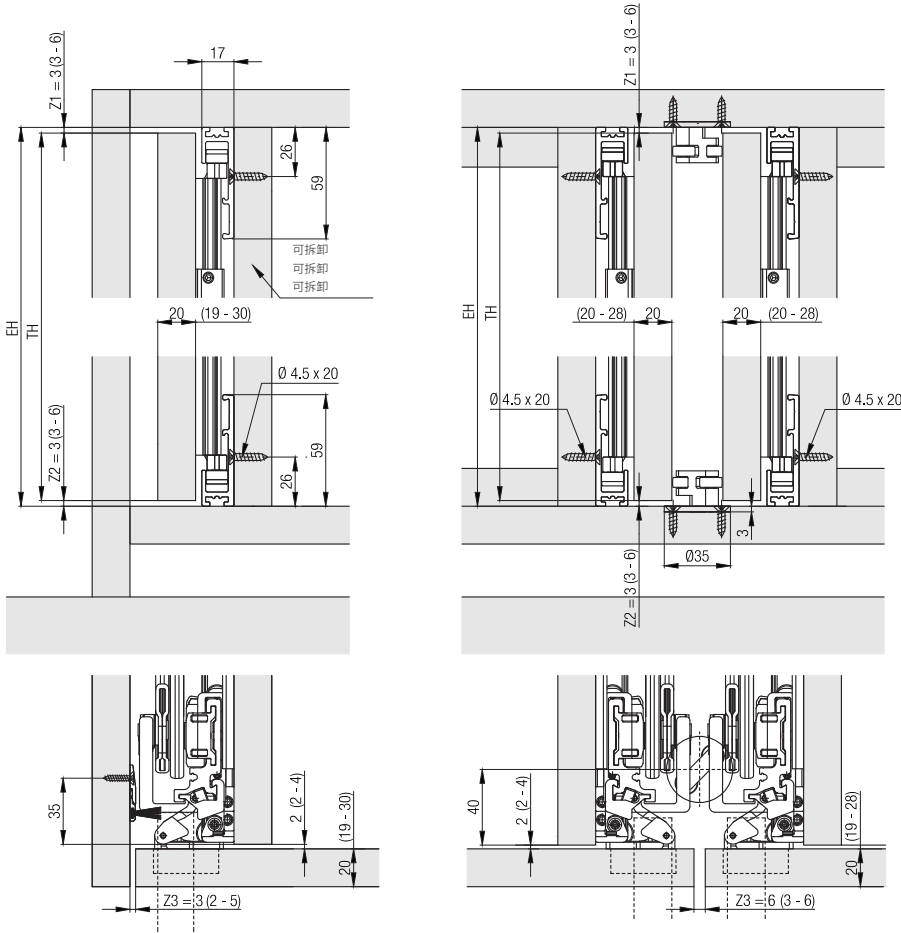

入墙式柜门

柜门厚度: 31-50 mm

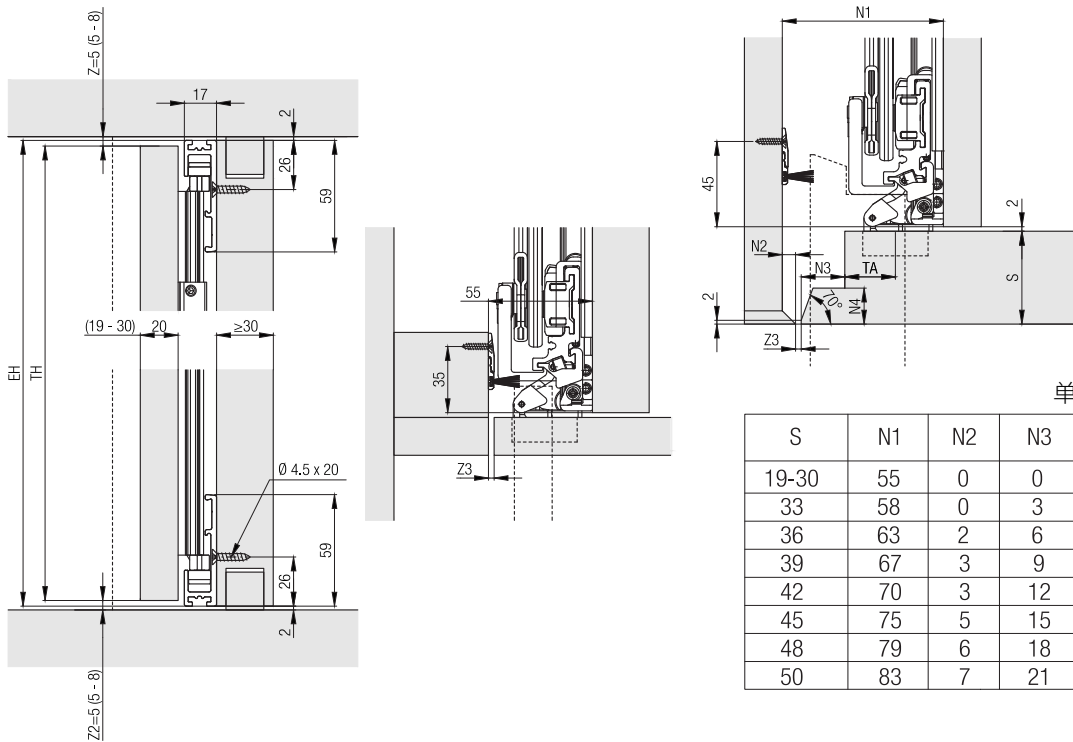

单位:mm

S	N1	N2	N3	N4
19-30	55	0	0	0
33	58	0	3	3
36	63	2	6	5
39	67	3	9	8
42	70	3	12	11
45	75	5	15	14
48	79	6	18	17
50	83	7	21	19

安装深度计算

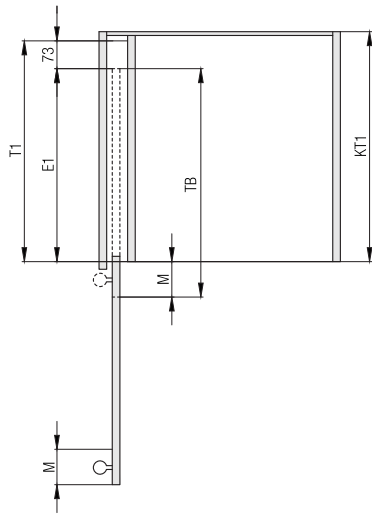

单位:mm

$$T1 = TB - M + 73$$

$$E1 = T1 - 73$$

单位:mm

	T1	TH	E1
Hawa Concepta 30	≤ 900	1851 - 2300	300 - 827

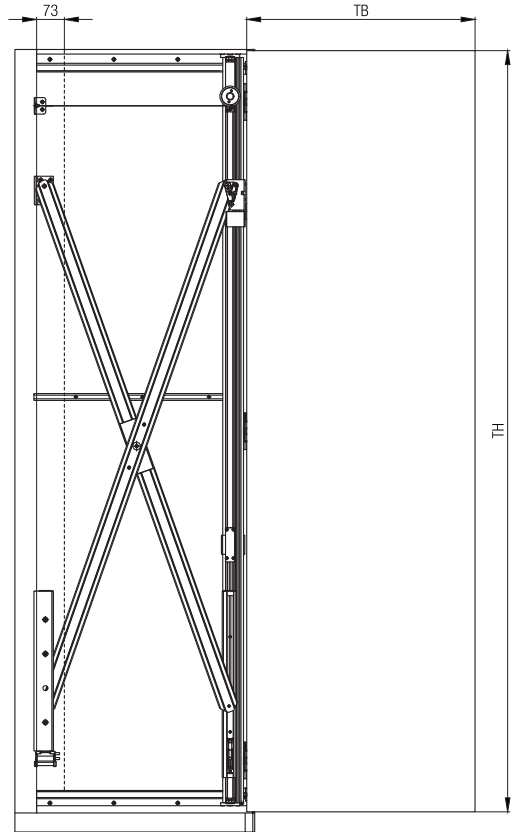

柜门重量及尺寸对照表

最大重量必须根据柜门的尺寸比进行调整。

TH	TB	300	350	400	450	500	550	600	650	700	750	800	850	900
2300	30	30	30	30	30	30	30	30	30	30	30	29	27	26
2250	30	30	30	30	30	30	30	30	30	30	30	28	27	25
2200	30	30	30	30	30	30	30	30	30	30	29	27	26	24
2150	30	30	30	30	30	30	30	30	30	30	29	27	25	24
2100	30	30	30	30	30	30	30	30	30	30	28	26	25	23
2050	30	30	30	30	30	30	30	30	30	29	27	25	24	23
2000	30	30	30	30	30	30	30	30	30	29	26	25	23	22
1950	30	30	30	30	30	30	30	29	27	26	24	23	21	
1900	30	30	30	30	30	30	30	29	27	25	23	22	21	
1851	30	30	30	30	30	30	30	28	26	24	23	21	20	

柜门重量 (kg) | TB=柜门宽度 (mm) | TH=柜门高度 (mm)

选装配件

- 门板拉直器, 从第50页开始



计划/实施

进入 www.concepta.hawa.com, 输入柜体基本尺寸即可得设计方案深化图纸。



有关该产品的更多信息, 请访问 www.hawa.com。

适用于40kg旋转推入式木门, 齐平式设计能够满足多功能空间自由转换

产品亮点

-  **灵活** 门板尺寸灵活, 设计自由度高
-  **舒适** 采用阻尼回收系统和集成式阻尼铰链, 操作柔顺、静音

技术标准

-  门板重量 20-40 kg
-  门板高度 1851-2500 mm
-  门板宽度 300-900 mm
-  门板厚度 19-50 mm

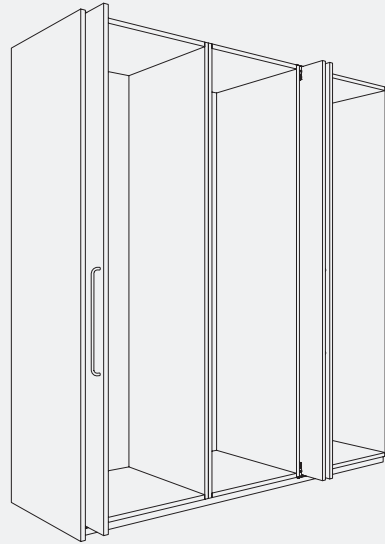

安装实例 外盖式柜门

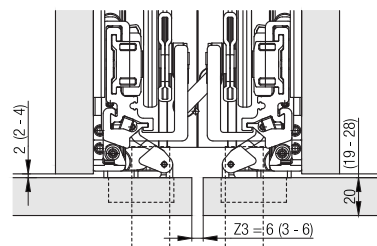
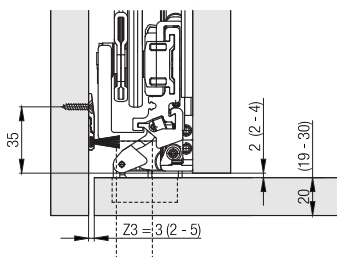
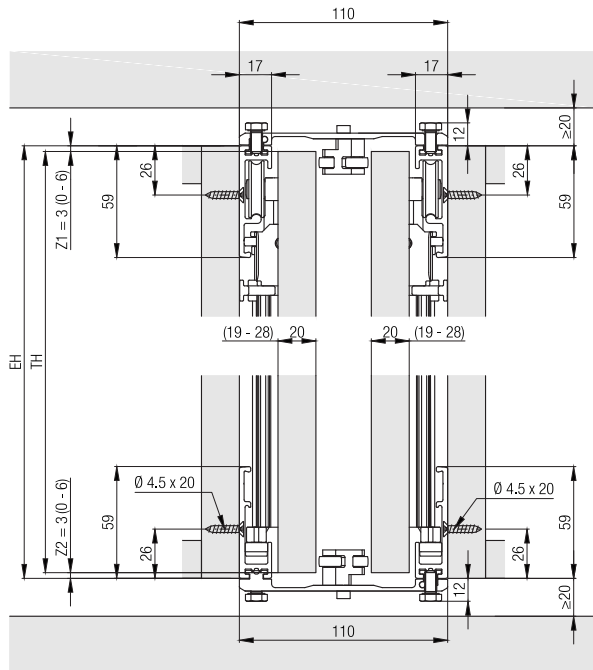
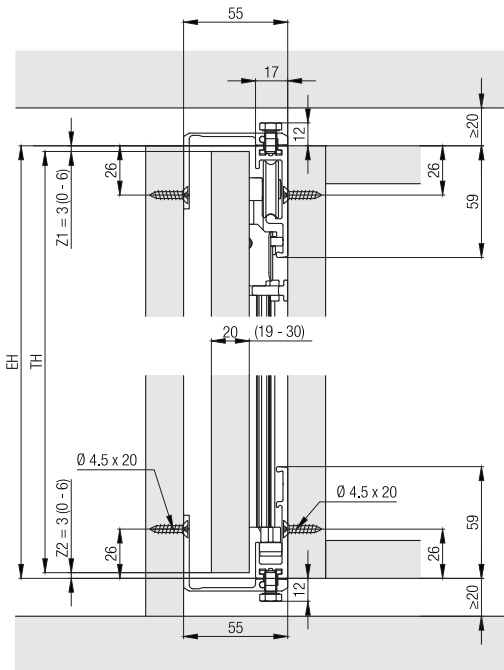







40kg旋转推入式移门套装配件

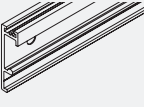
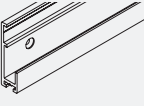

Hawa Concepta 40, 单门		编号	
		27650	
全套配件包括:		27650	编号
	立柱, 2500 mm, 氧化铝	1	22056
	立柱承重轮, 带扭力盘, 高度可调, 铝	1	24955
	立柱导向装置, 防震, 带塑料滚轮	1	25656
	剪刀支架, 1500 mm, 镀锌钢	1	22594
	剪刀支架前导轨, 氧化铝	1	25592
	剪刀支架后导轨, 氧化铝	1	25596
	剪刀支架限位器, 55 mm, 镀锌钢	1	25855
	隐藏式铰链, 带阻尼器, 镀锌钢, 4件/套	1	27655
	隐藏式铰链专用螺丝, 4x16 mm, 10件/套	1	25935
	限位胶条, 860 mm, 预钻孔, 塑料, 黑色	1	22861
	限位胶条专用十字头螺丝, 4x16 mm, 7件/套	1	25562

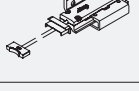
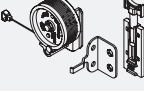
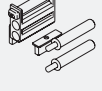
续表见下一栏

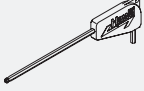
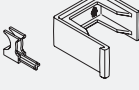
接上一栏

	导向静音毛刷, 塑料, 黑色, 3件/套	1	25815
	顶部导轨, 896 mm, 氧化铝, 预钻孔	1	24528
	底部导轨, 896 mm, 氧化铝, 预钻孔	1	24535
	锁止器, Hawa Concepta, 深度可调, 左上角/右下角	1	27657
	锁止器, Hawa Concepta, 深度可调, 右上角/左下角	1	27658
	盖板, 不锈钢, 1对	1	24739
	前导轨阻尼器, 带固定架	1	24660
	柜门伸缩器30/40, 带阻尼器, 塑料, 黑色	1	25813
	后导轨阻尼器, 带罩盖, 塑料, 黑色	1	25862
	螺丝, 4.5x20 mm, 22件/套	1	22451
	内六角扳手, 带手柄, 3 mm	1	13164
	辅助安装工具, 塑料, 红色	1	25816

口袋连接器

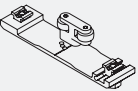
		mm	编号
	55 mm口袋连接器, 单门, 氧化铝, 2件	650	25438
	55 mm口袋连接器, 单门, 氧化铝, 1件	650	23221
		900	23222
	110 mm口袋连接器, 两门, 氧化铝, 1件	650	23223
		900	23224
	110 mm口袋连接器, 两门, 氧化铝, 1件 (安装在固定的底座前面)	26	23225

导向轮

		编号
	嵌入式旋转滑动柜门(两门)专用导向轮, 铝	25680

门板拉手

		mm	编号
	门板拉手, 氧化铝	400	22692

门板拉手高度

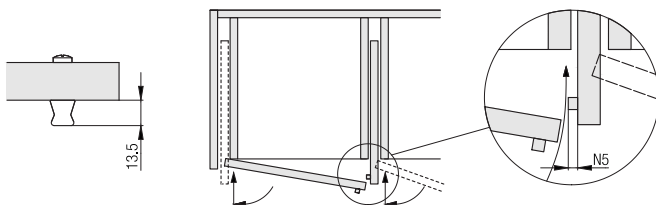

其他安装实例
齐平式柜门

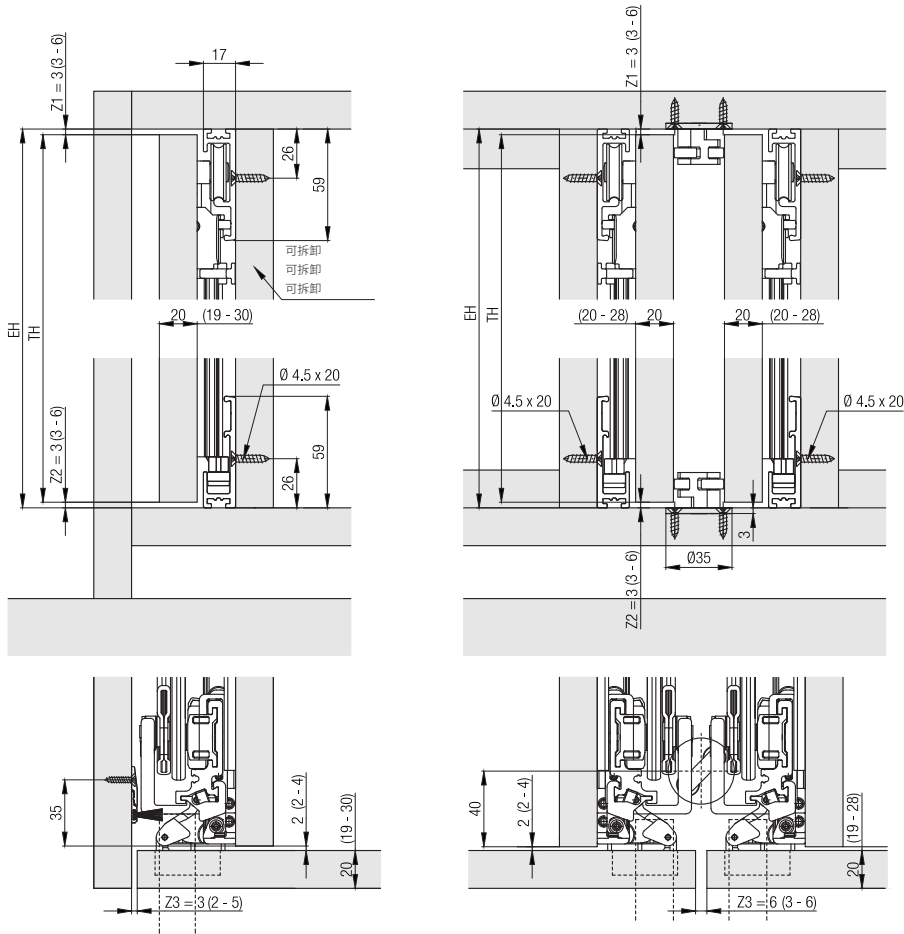

入墙式柜门

柜门厚度: 31-50 mm

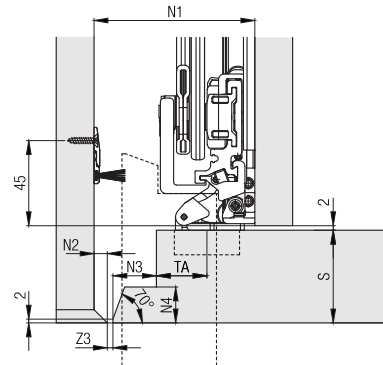
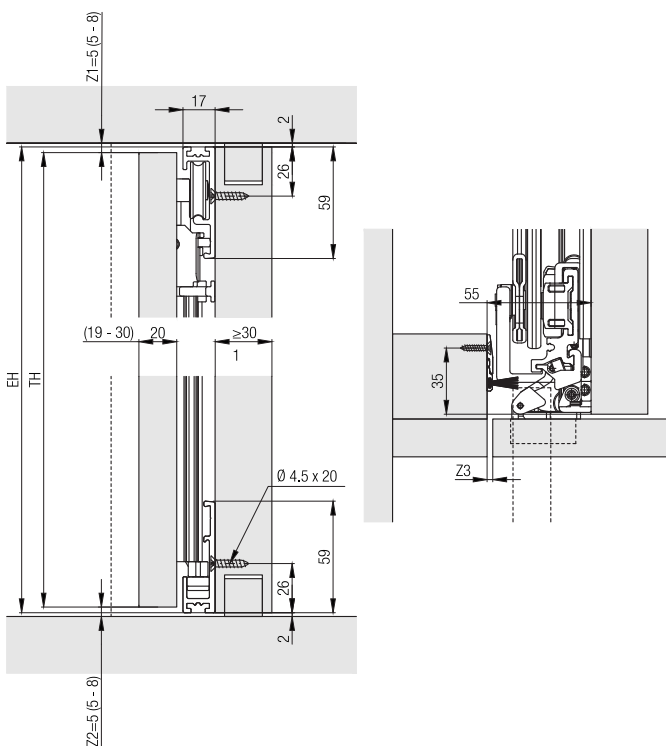

单位:mm

S	N1	N2	N3	N4
19-30	55	0	0	0
33	58	0	3	3
36	63	2	6	5
39	67	3	9	8
42	70	3	12	11
45	75	5	15	14
48	79	6	18	17
50	83	7	21	19

安装深度计算

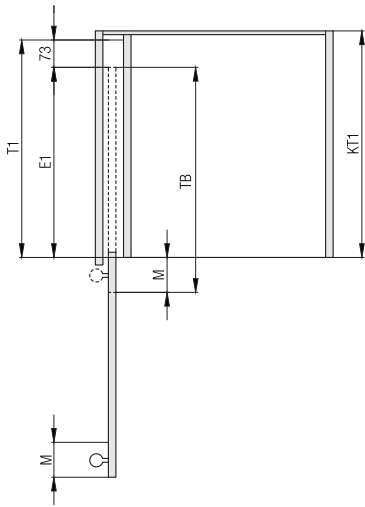

单位:mm

$$T1 = TB - M + 73$$

$$E1 = T1 - 73$$

单位:mm

	T1	TH	E1
Hawa Concepta 40	≤ 900	1851 - 2500	300 - 827

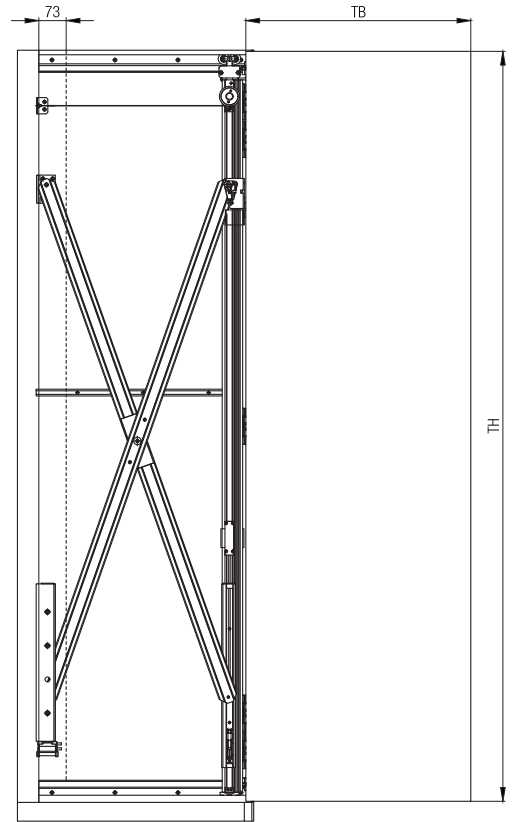

柜门重量及尺寸对照表

门板重量必须根据柜门的尺寸比进行调整。

TH \ TB	300	350	400	450	500	550	600	650	700	750	800	850	900
2500	40	40	40	40	40	40	40	40	40	37	34	32	31
2450	40	40	40	40	40	40	40	40	39	36	34	32	30
2400	40	40	40	40	40	40	40	40	38	35	33	31	29
2350	40	40	40	40	40	40	40	40	37	34	32	30	29
2300	40	40	40	40	40	40	40	39	36	33	31	30	28
2250	40	40	40	40	40	40	40	38	35	33	31	29	27
2200	40	40	40	40	40	40	40	37	34	32	30	28	27
2150	40	40	40	40	40	40	39	36	33	31	29	27	26
2100	40	40	40	40	40	40	38	35	32	31	28	27	25
2050	40	40	40	40	40	40	37	34	31	30	28	26	24
2000	40	40	40	40	40	39	36	33	31	29	27	25	24
1950	40	40	40	40	40	38	35	32	30	28	26	24	23
1900	40	40	40	40	40	37	34	31	29	27	25	24	22
1851	40	40	40	40	39	36	33	30	28	26	24	23	22

柜门重量 (kg) | TB=柜门宽度 (mm) | TH=柜门高度 (mm)

选装配件

- 门板拉直器, 从第50页开始



计划/实施

进入 www.concepta.hawa.com, 输入柜体基本尺寸即可得设计方案深化图纸。





有关该产品的更多信息, 请访问 www.hawa.com。

适用于50kg旋转推入式木门, 齐平式设计能够满足多功能空间自由转换

产品亮点

-  **灵活** 门板尺寸灵活, 设计自由度高
-  **舒适** 采用阻尼回收系统和集成式阻尼铰链, 操作柔顺、静音

技术标准

-  门板重量 25-50 kg
-  门板高度 2301-2850 mm
-  门板宽度 300-900 mm
-  门板厚度 19-50 mm

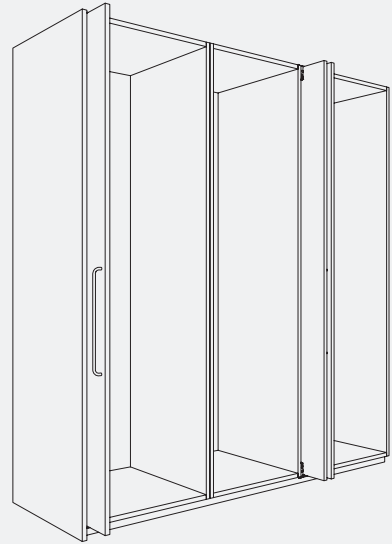

安装实例 外盖式柜门

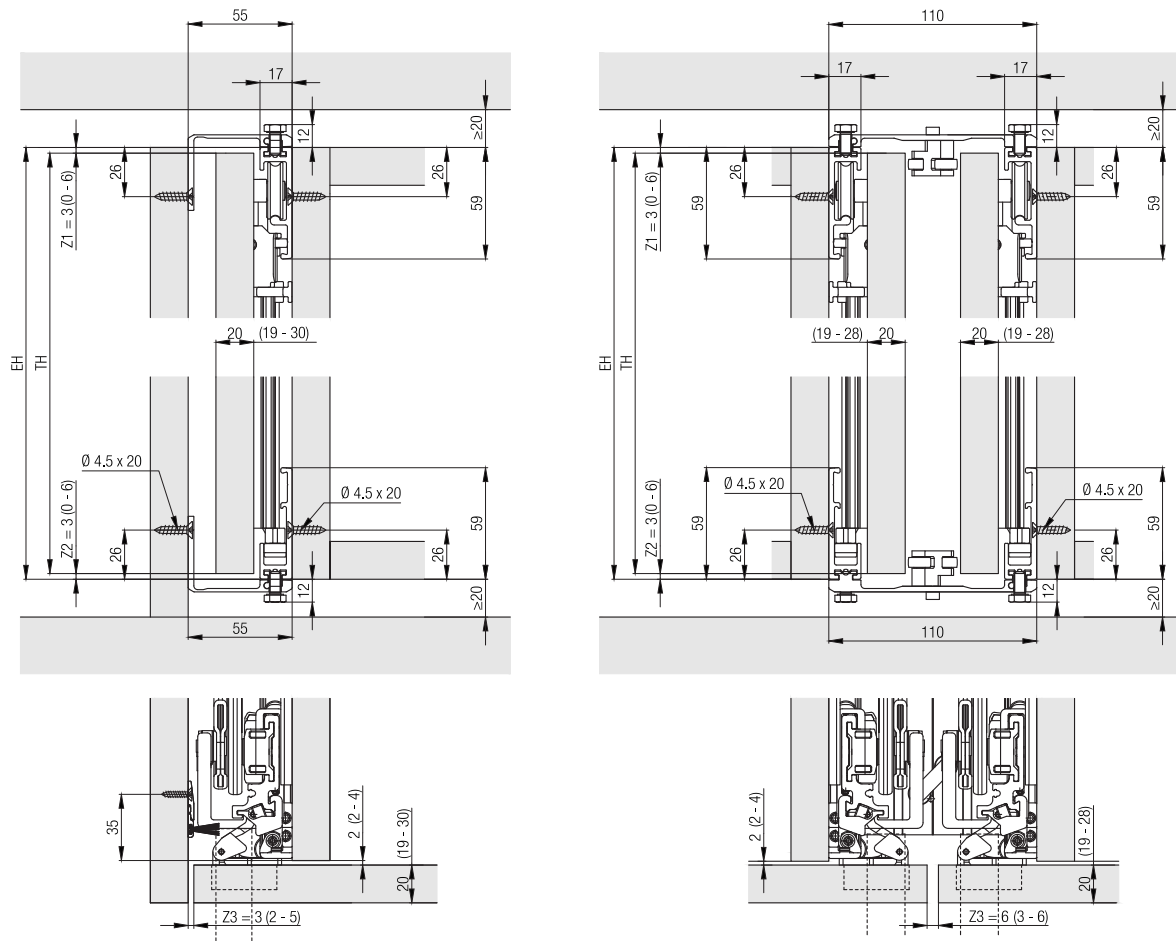

50kg旋转推入式移门套装配件

接上一栏

		编号	
Hawa Concepta 50, 单门		27651	
全套配件包括:		27651	编号
	立柱, 2760 mm, 氧化铝	1	22057
	立柱承重轮, 带扭力盘, 高度可调, 铝	1	24955
	立柱导向装置, 防震, 带塑料滚轮	1	25656
	剪刀支架, 1500 mm, 镀锌钢	1	22594
	剪刀支架前导轨, 氧化铝	1	25592
	剪刀支架后导轨, 氧化铝	1	25596
	剪刀支架限位器, 55 mm, 镀锌钢	1	25855
	隐藏式铰链, 带阻尼器, 镀锌钢, 5件/套	1	27656
	隐藏式铰链专用螺丝, 4x16 mm, 10件/套	1	25935
	限位胶条, 860 mm, 预钻孔, 塑料, 黑色	1	22861
	限位胶条专用十字头螺丝, 4x16 mm, 7件/套	1	25562

	导向静音毛刷, 塑料, 黑色, 3件/套	1	25815
	顶部导轨, 896 mm, 氧化铝, 预钻孔	1	24528
	底部导轨, 896 mm, 氧化铝, 预钻孔	1	24535
	前导轨阻尼器, 带固定架	1	24660
	柜门伸缩器25/50, 带阻尼器, 塑料, 黑色	1	25814
	锁止器, Hawa Concepta, 深度可调, 左上角/右下角	1	27657
	锁止器, Hawa Concepta, 深度可调, 右上角/左下角	1	27658
	盖板, 不锈钢, 1对	1	24739
	后导轨阻尼器, 带罩盖, 塑料, 黑色	1	25862
	螺丝, 4.5x20 mm, 22件/套	1	22451
	内六角扳手, 带手柄, 3 mm	1	13164
	辅助安装工具, 塑料, 红色	1	25816

续表见下一栏

口袋连接器

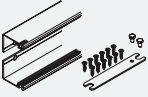
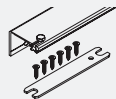
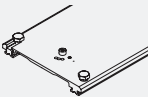
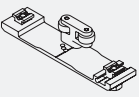
		mm	编号
	55 mm口袋连接器, 单门, 氧化铝, 2件	650	25438
	55 mm口袋连接器, 单门, 氧化铝, 1件	650	23221
		900	23222
	110 mm口袋连接器, 两门, 氧化铝, 1件	650	23223
		900	23224
	110 mm口袋连接器, 两门, 氧化铝, 1件 (安装在固定的底座前面)	26	23225

导向轮

		编号
	嵌入式旋转滑动柜门(两门)专用导向轮, 铝	25680

门板拉手

		mm	编号
	门板拉手, 氧化铝	400	22692

门板拉手高度

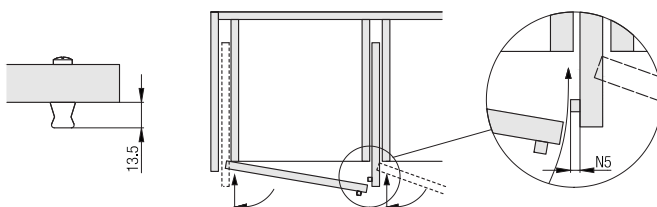

其他安装实例
齐平式柜门

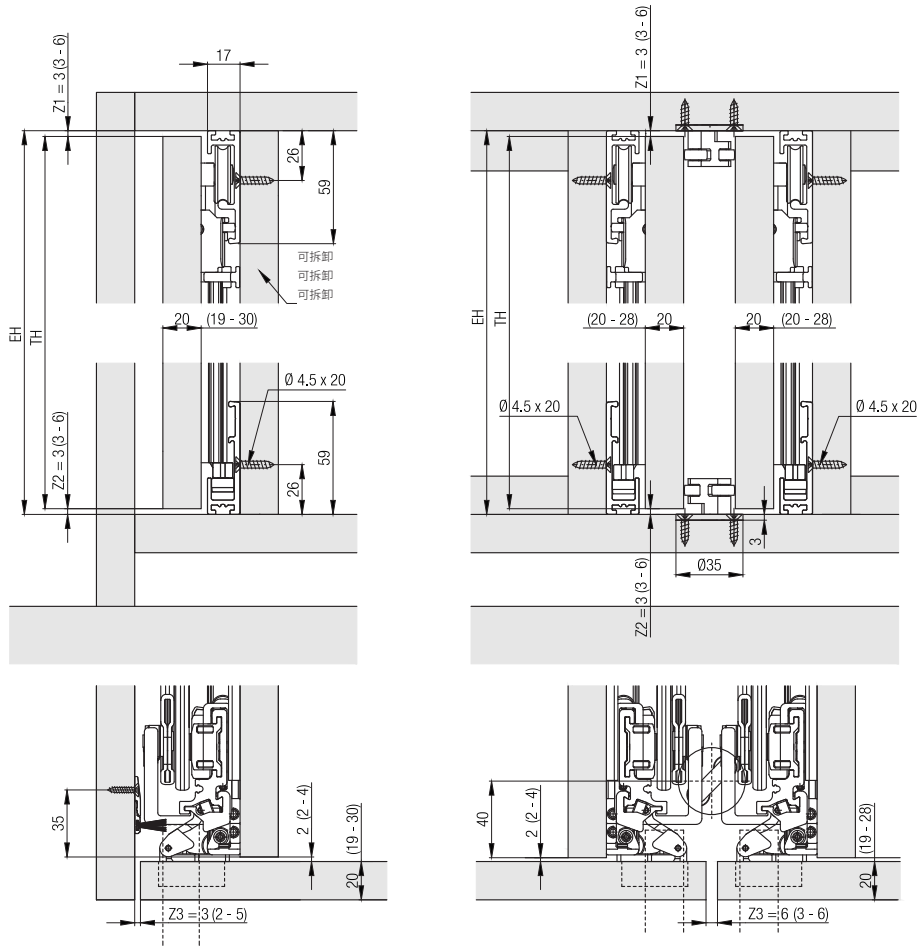

入墙式柜门

柜门厚度: 31-50 mm

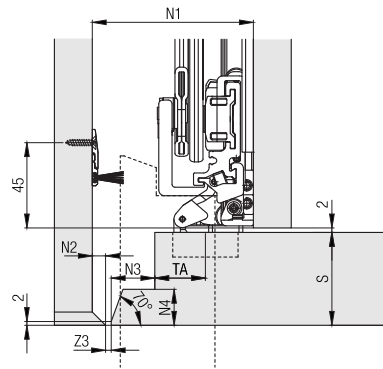
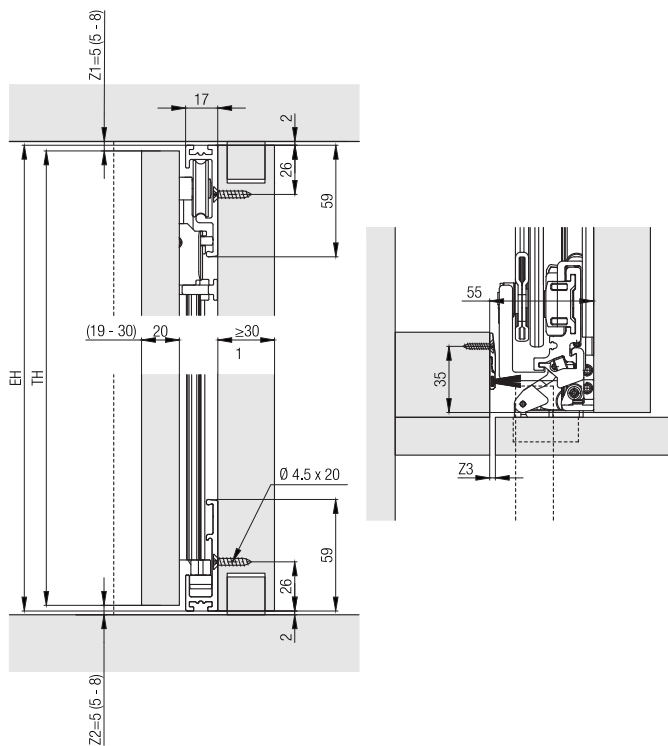

单位:mm

S	N1	N2	N3	N4
19-30	55	0	0	0
33	58	0	3	3
36	63	2	6	5
39	67	3	9	8
42	70	3	12	11
45	75	5	15	14
48	79	6	18	17
50	83	7	21	19

安装深度计算

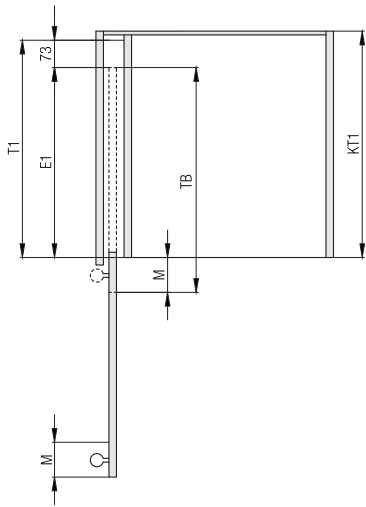

单位:mm

$$T1 = TB - M + 73$$

$$E1 = T1 - 73$$

单位:mm

	T1	TH	E1
Hawa Concepta 50	≤ 900	2301 - 2850	300 - 827

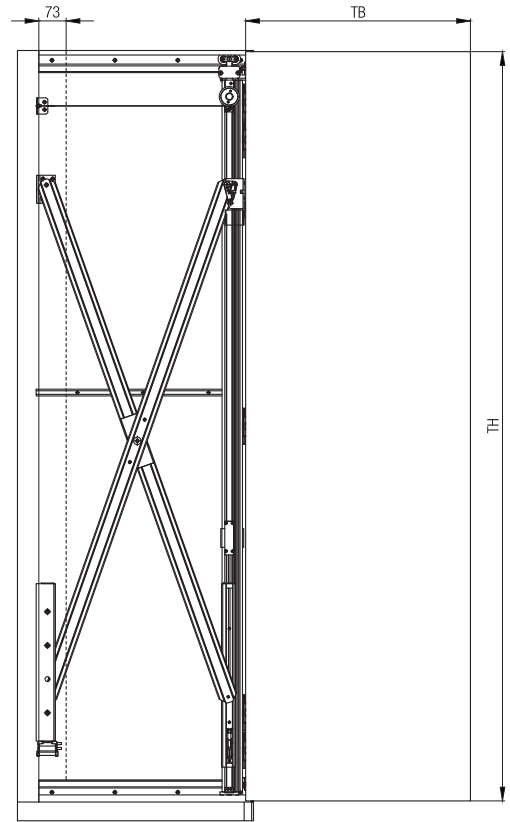

柜门重量及尺寸对照表

最大重量必须根据柜门的尺寸比进行调整。

TH \ TB	300	350	400	450	500	550	600	650	700	750	800	850	900
2850	50	50	50	50	50	50	50	50	50	50	50	50	50
2800	50	50	50	50	50	50	50	50	50	50	50	50	50
2750	50	50	50	50	50	50	50	50	50	50	50	50	50
2700	50	50	50	50	50	50	50	50	50	50	50	50	49
2650	50	50	50	50	50	50	50	50	50	50	50	50	48
2600	50	50	50	50	50	50	50	50	50	50	50	49	48
2550	50	50	50	50	50	50	50	50	50	50	50	48	47
2500	50	50	50	50	50	50	50	50	50	50	49	48	46
2450	50	50	50	50	50	50	50	50	50	49	48	47	45
2400	50	50	50	50	50	50	50	50	50	48	48	46	45
2350	50	50	50	50	50	50	50	50	49	48	47	45	44
2301	50	50	50	50	50	50	50	49	48	47	46	45	43

柜门重量 (kg) | TB=柜门宽度 (mm) | TH=柜门高度 (mm)

选装配件

- 门板拉直器, 从第50页开始

计划/实施

进入www.concepta.hawa.com, 输入柜体基本尺寸即可得设计方案深化图纸。

有关该产品的更多信息, 请访问www.hawa.com。